

Pallet Specification Sheet

Pallet ID: ppc2741-2B45F

Top View:

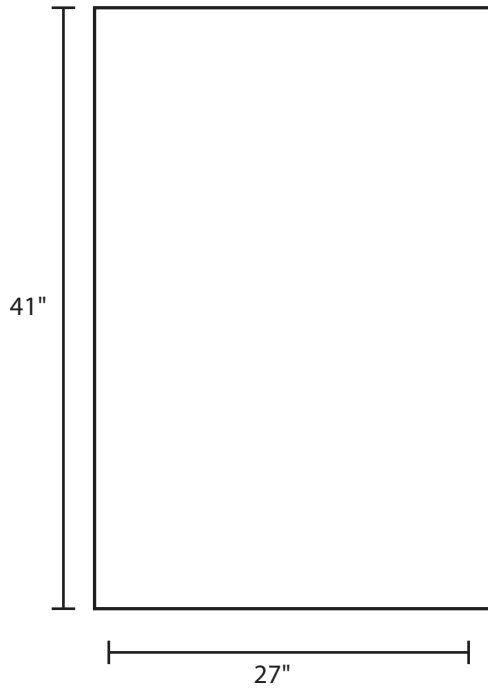

Bottom View:

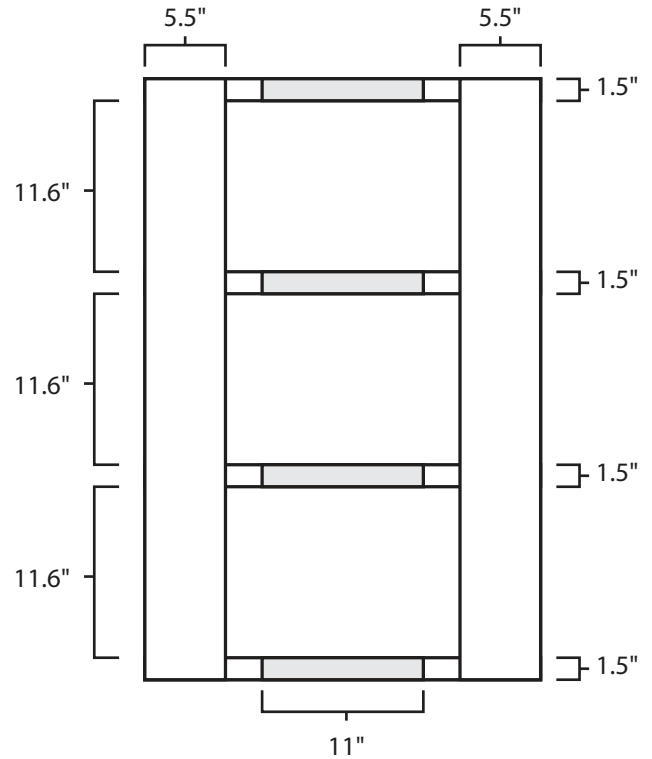

Side View:

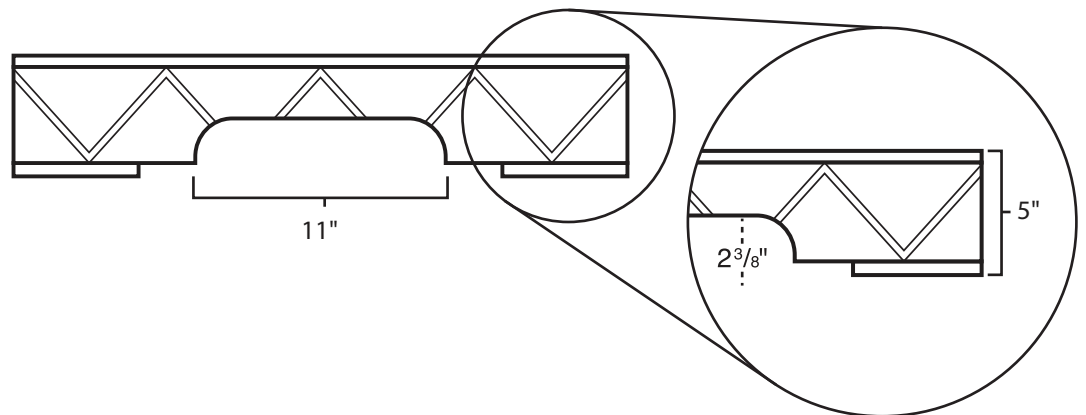

Components & Specifications:

Dimensions: 27" x 41" x 5"

Weight: 30lbs

Stackable

Dynamic Capacity: 2,000lbs

Static Capacity: 15,000lbs

#10-12X1-1/2 Screws

All parts made of recycled plastic

All parts made in USA

Pallet is fully recyclable

Tolerances +/- 3/8"