

Pallet Specification Sheet

Pallet ID: ppc4060-4B45F-3XS

Top View:

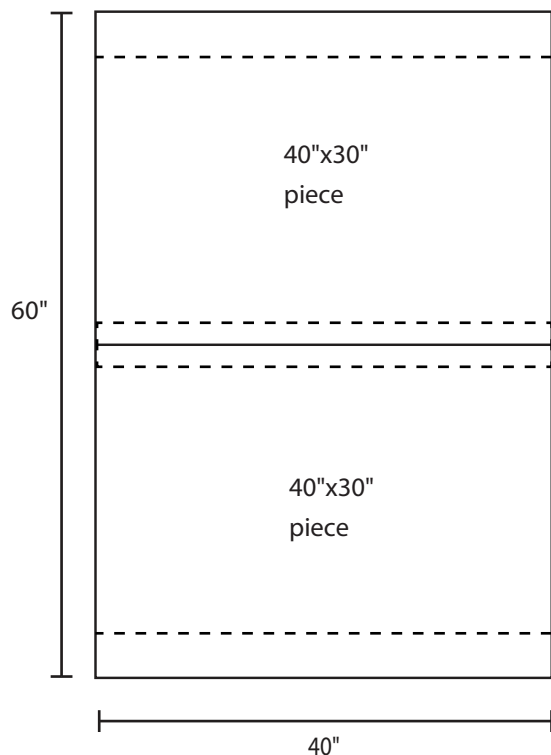

Bottom View:

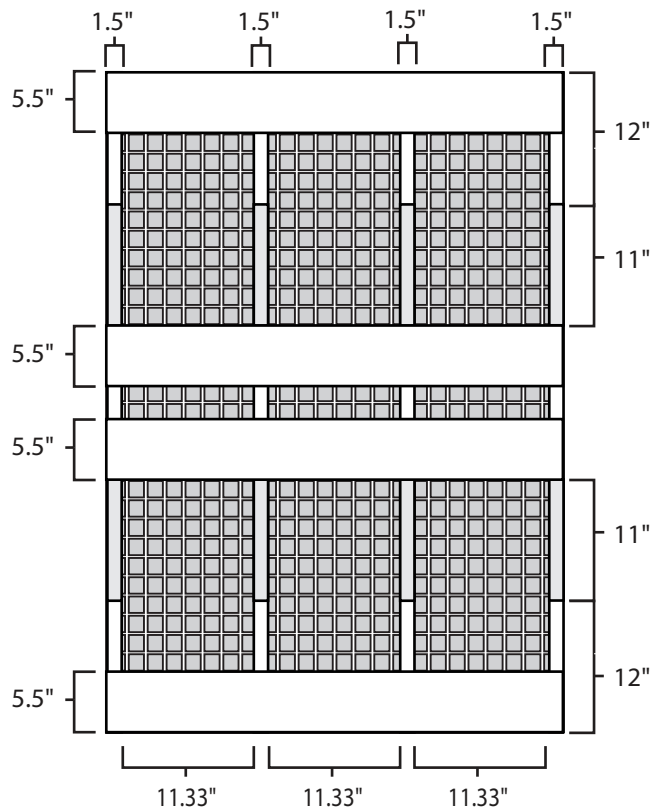

Side View:

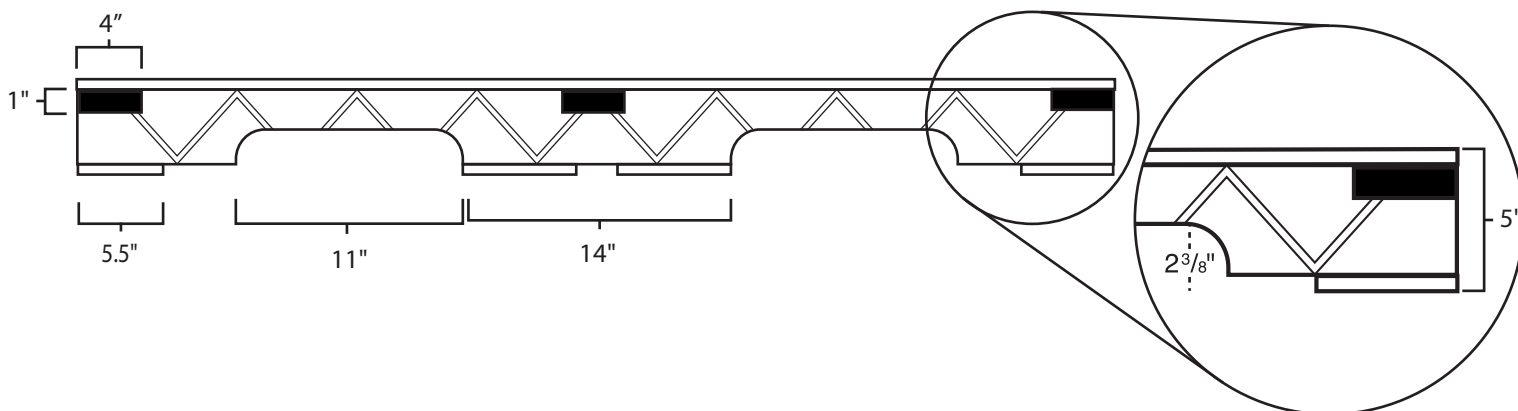

Components & Specifications:

Dimensions: 40" x 60" x 5"
Weight: 80lbs
Stackable

Dynamic Capacity: 2,600lbs
Static Capacity: 15,000lbs
#10-12X1-1/2 Screws

All parts made of recycled plastic
All parts made in USA
Pallet is fully recyclable

Tolerances +/- 3/8"