

Pallet Specification Sheet

Pallet ID: ppc4545-4B45F-2XS

Top View:

Bottom View:

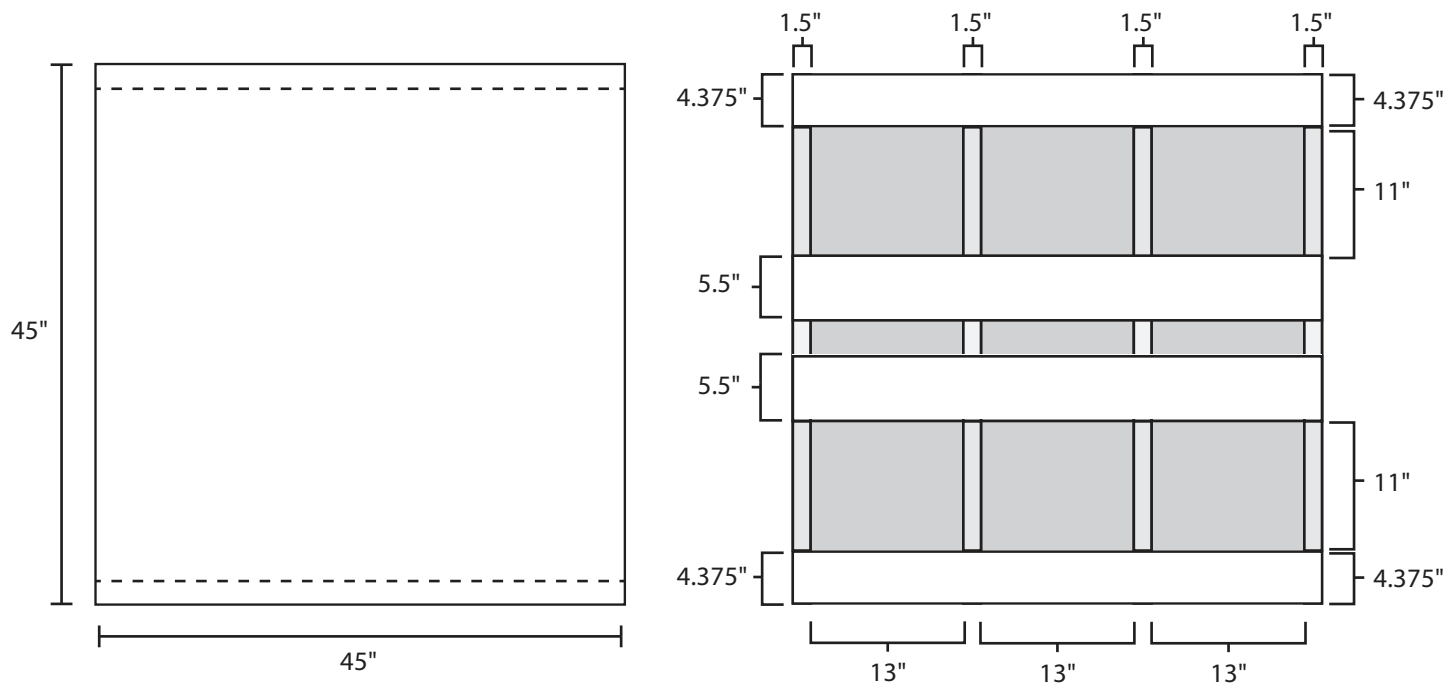

Side View:

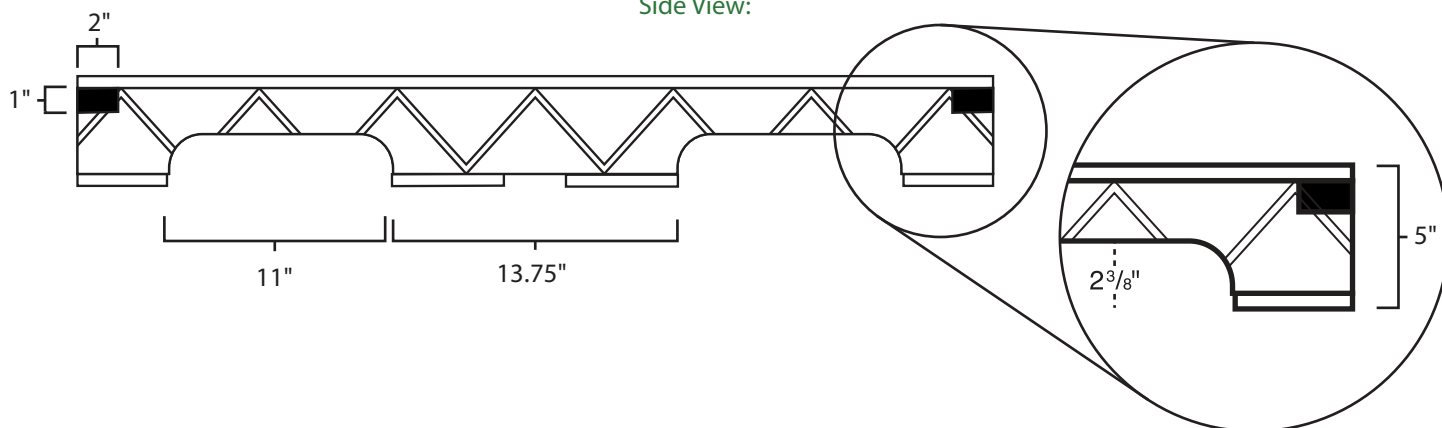

Components & Specifications:

Dimensions: 45" x 45" x 5"
Weight: 60lbs
Stackable

Dynamic Capacity: 2,000lbs
Static Capacity: 15,000lbs
#10-12X1-1/2 Screws

All parts made of recycled plastic
All parts made in USA
Pallet is fully recyclable
Tolerances +/- 3/8"