

# Pallet Specification Sheet

Pallet ID: ppc4848-3B35F

Top View:

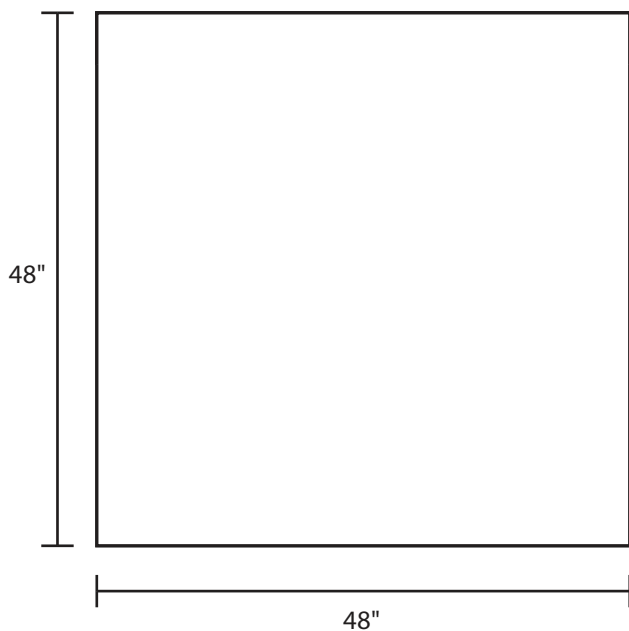

Bottom View:

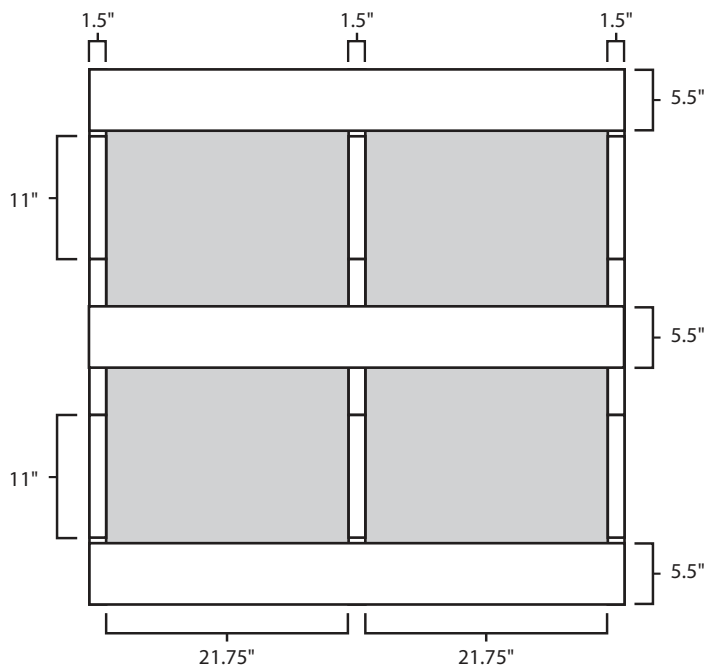

Side View:

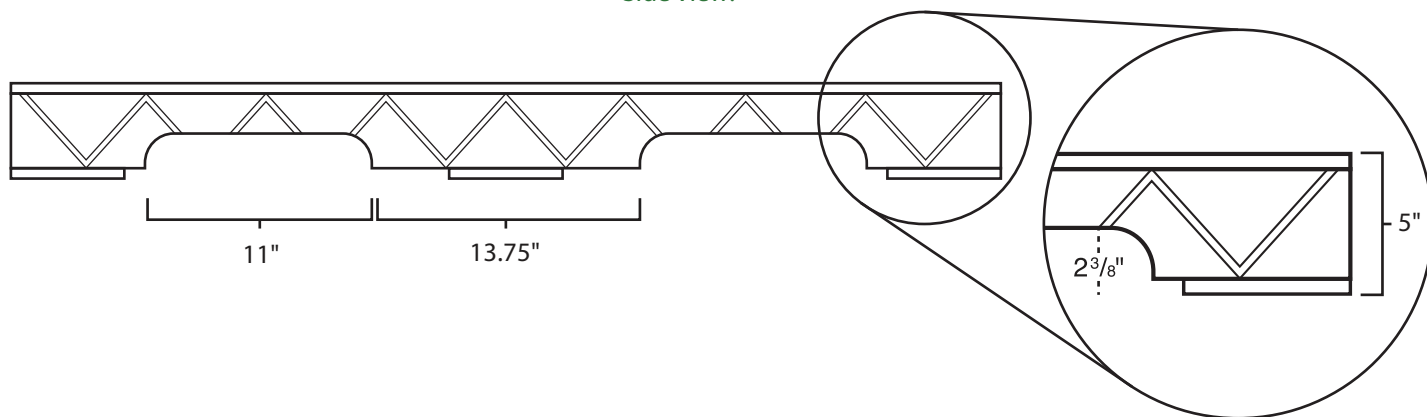

## Components & Specifications:

Dimensions: 48" x 48" x 5"  
Weight: 51lbs  
Stackable

Dynamic Capacity: 1,500lbs  
Static Capacity: 15,000lbs  
#10-12X1-1/2 Screws

All parts made of recycled plastic  
All parts made in USA  
Pallet is fully recyclable

Tolerances +/- 3/8"